

# DATA SHEET



## GaAs HJ-FET INTEGRATED CIRCUIT $\mu$ PG2253T6S

### RF FRONT-END IC FOR 2.4 GHz Bluetooth™, ZIGBEE, ISM BAND

#### DESCRIPTION

The  $\mu$ PG2253T6S is a RF front-end integrated circuit (FEIC) for Bluetooth Class 1, ZigBee, and ISM Band and includes TX/Bypass switches, a power amplifier, and a low-pass filter. This device does not require any RF matching parts.

The  $\mu$ PG2253T6S operates with 3.0 V supply and provides high efficiency and low harmonics. This device is housed in a 16-pin plastic QFN (Quad Flat Non-leaded (T6S) package, and is suitable for high-density surface mounting.

#### FEATURES

- Operating frequency :  $f_{opt} = 2\ 400$  to  $2\ 500$  MHz (2 450 MHz TYP.)
- Supply voltage :  $V_{DD1, 2, 3} = 3.0$  V TYP.
- Control voltage :  $V_{en} = 3.0$  V TYP.
- Circuit current :  $I_{DD} = 95$  mA TYP. @  $P_{in} = 0$  dBm
- Output power :  $P_{out} = 19$  dBm TYP. @  $P_{in} = 0$  dBm
- High efficiency : PAE = 28% TYP. @  $P_{in} = 0$  dBm
- High-density surface mounting : 16-pin plastic QFN package (T6S) (3.0 × 3.0 × 0.75 mm)

#### APPLICATIONS

- Front-end IC for 2.4 GHz Bluetooth Class 1, ZigBee™, ISM Band

#### ORDERING INFORMATION

Part Number	Order Number	Package	Marking	Supplying Form
$\mu$ PG2253T6S-E2	$\mu$ PG2253T6S-E2-A	16-pin plastic QFN (T6S) (Pb-Free)	G5Y	<ul style="list-style-type: none"><li>• Embossed tape 8 mm wide</li><li>• Pin 10, 11, 12 face the perforation side of the tape</li><li>• Qty 3 kpcs/reel</li></ul>

**Remark** To order evaluation samples, please contact your nearby sales office.

Part number for sample order:  $\mu$ PG2253T6S-A

**Caution** Although this device is designed to be as robust as possible, ESD (Electrostatic Discharge) can damage this device. This device must be protected at all times from ESD. Static charges may easily produce potentials of several kilovolts on the human body or equipment, which can discharge without detection. Industry-standard ESD precautions must be employed at all times.

The information in this document is subject to change without notice. Before using this document, please confirm that this is the latest version.

**PIN CONNECTIONS AND INTERNAL BLOCK DIAGRAM**

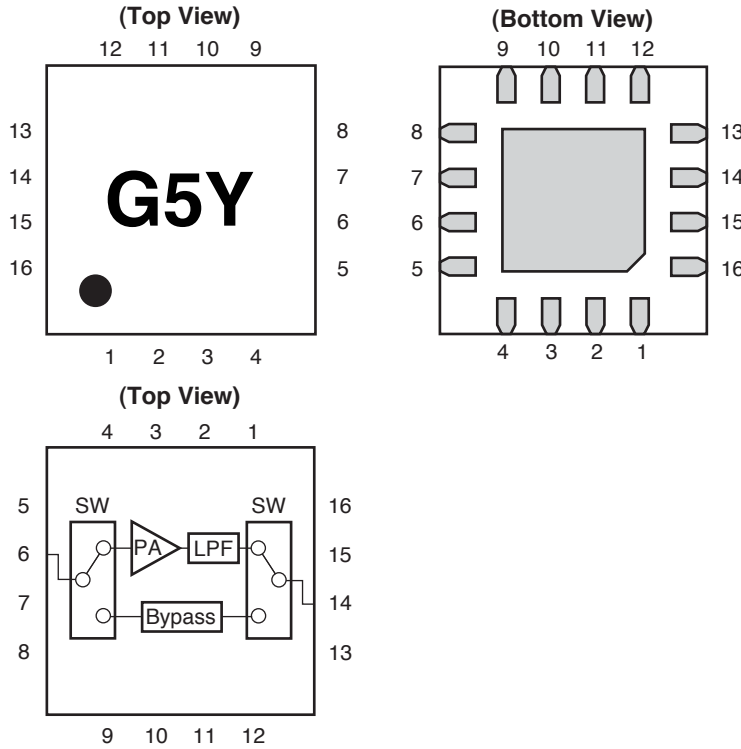

Pin No.	Pin Name
1	GND
2	N.C.
3	V <sub>en</sub>
4	N.C.
5	N.C.
6	RFin
7	N.C.
8	GND
9	V <sub>b1</sub>
10	V <sub>b2</sub>
11	V <sub>b3</sub> (1)
12	V <sub>b3</sub> (2)
13	GND
14	ANT
15	V <sub>sw1</sub>
16	V <sub>sw2</sub>

**Remark** Exposed pad : GND

**TRUTH TABLE**

V <sub>sw1</sub>	V <sub>sw2</sub>	Tx	Bypass Path
3.0 V	0 V	ON	OFF
0 V	3.0 V	OFF	ON

**ABSOLUTE MAXIMUM RATINGS (T<sub>A</sub> = +25°C, unless otherwise specified)**

Parameter	Symbol	Ratings	Unit
Supply Voltage	V <sub>DD1, 2, 3</sub>	5.0	V
Control Voltage	V <sub>en</sub>	4.0	V
Switching Voltage	V <sub>sw1, 2</sub>	5.0	V
Input Power	P <sub>in</sub>	+5	dBm
Power Dissipation	P <sub>D</sub>	400 <sup>Note</sup>	mW
Operating Ambient Temperature	T <sub>A</sub>	-45 to +85	°C
Storage Temperature	T <sub>stg</sub>	-55 to +150	°C

**Note** Mounted on double-sided copper-clad 50 × 50 × 1.6 mm epoxy glass PWB, T<sub>A</sub> = +85°C.

**RECOMMENDED OPERATING RANGE (TA = +25°C, unless otherwise specified)**

Parameter	Symbol	MIN.	TYP.	MAX.	Unit
Operating Frequency	f <sub>opt</sub>	2,400	2,450	2,500	MHz
Supply Voltage	V <sub>DD1, 2, 3</sub>	2.7	3.0	3.6	V
Switch Control Voltage (H)	V <sub>sw1, 2</sub>	1.8	3.0	3.6	V
Switch Control Voltage (L)	V <sub>sw1, 2</sub>	-0.2	0.0	0.2	V
Control Voltage (H)	V <sub>en</sub>	1.5	3.0	3.6	V
Control Voltage (L)	V <sub>en</sub>	-	0	0.2	V

**ELECTRICAL CHARACTERISTICS (TA = +25°C, V<sub>DD1, 2, 3</sub> = 3.0 V, f = 2,400 to 2,500 MHz, unless otherwise specified)**

Parameter	Symbol	Test Conditions	MIN.	TYP.	MAX.	Unit
PA Circuit Current	I <sub>DD</sub>	P <sub>in</sub> = 0 dBm, V <sub>en</sub> = 3.0 V, V <sub>sw1</sub> /V <sub>sw2</sub> = 3.0/0 V	-	95	120	mA
Switch Current	I <sub>sw</sub>	RF off, V <sub>sw1</sub> /V <sub>sw2</sub> = 3.0/0 V	-	10	40	μA
Shut Down Current	I <sub>shut down</sub>	P <sub>in</sub> = -30 dBm, V <sub>en</sub> = 0 V, V <sub>sw1</sub> /V <sub>sw2</sub> = 3.0/0 V	-	4	15	μA
Output Power	P <sub>out</sub>	P <sub>in</sub> = 0 dBm, V <sub>en</sub> = 3.0 V, V <sub>sw1</sub> /V <sub>sw2</sub> = 3.0/0 V	17.5	19	-	dBm
Power Efficiency	PAE	P <sub>in</sub> = 0 dBm, V <sub>en</sub> = 3.0 V, V <sub>sw1</sub> /V <sub>sw2</sub> = 3.0/0 V	-	28	-	%
Input Return Loss	RL <sub>in</sub>	P <sub>in</sub> = -30 dBm, V <sub>en</sub> = 3.0 V, V <sub>sw1</sub> /V <sub>sw2</sub> = 3.0/0 V	-	-10	-	dB
Output Return Loss	RL <sub>out</sub>	P <sub>in</sub> = -30 dBm, V <sub>en</sub> = 3.0 V, V <sub>sw1</sub> /V <sub>sw2</sub> = 3.0/0 V	-	-8	-	dB
2nd Harmonics	2f <sub>0</sub>	P <sub>in</sub> = 0 dBm, V <sub>en</sub> = 3.0 V, V <sub>sw1</sub> /V <sub>sw2</sub> = 3.0/0 V	-	-25	-	dBm
3rd Harmonics	3f <sub>0</sub>	P <sub>in</sub> = 0 dBm, V <sub>en</sub> = 3.0 V, V <sub>sw1</sub> /V <sub>sw2</sub> = 3.0/0 V	-	-40	-	dBm
Insertion Loss (Bypass mode)	L <sub>ins</sub>	P <sub>in</sub> = -30 dBm, V <sub>en</sub> = 0 V, V <sub>sw1</sub> /V <sub>sw2</sub> = 0/3.0 V	-	1.5	2.0	dB

EVALUATION CIRCUIT

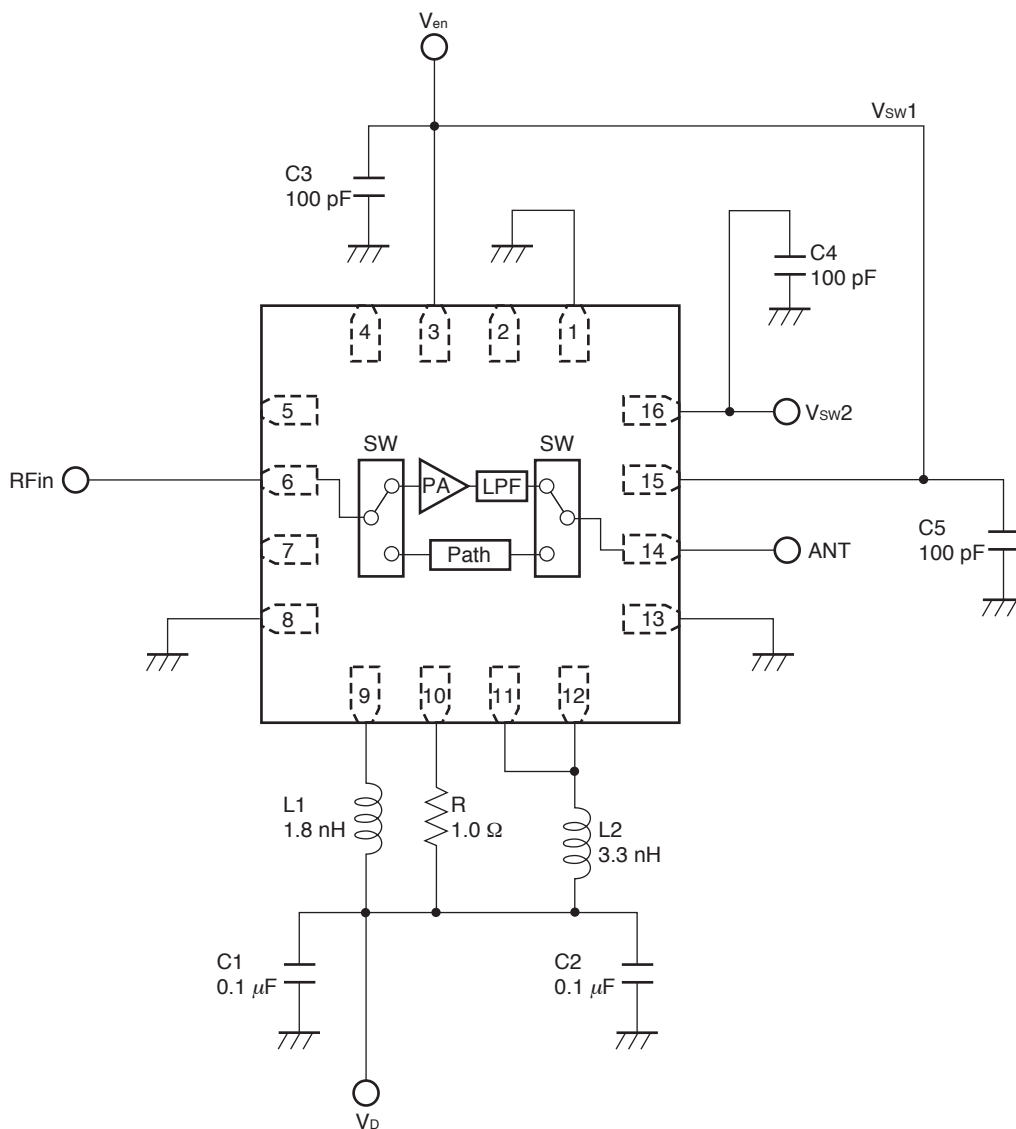

The application circuits and their parameters are for reference only and are not intended for use in actual design-ins.

**TYPICAL CHARACTERISTICS**

( $T_A = +25^\circ\text{C}$ ,  $V_{DD1, 2, 3} = 3.0\text{ V}$ ,  $V_{en} = 3.0\text{ V}$ ,  $V_{sw1}/V_{sw 2} = 3.0\text{ V}/0\text{ V}$ ,  $f = 2.45\text{ GHz}$ , unless otherwise specified)

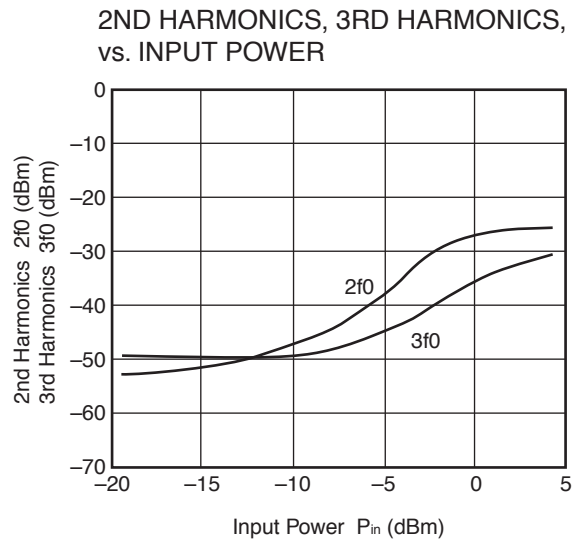
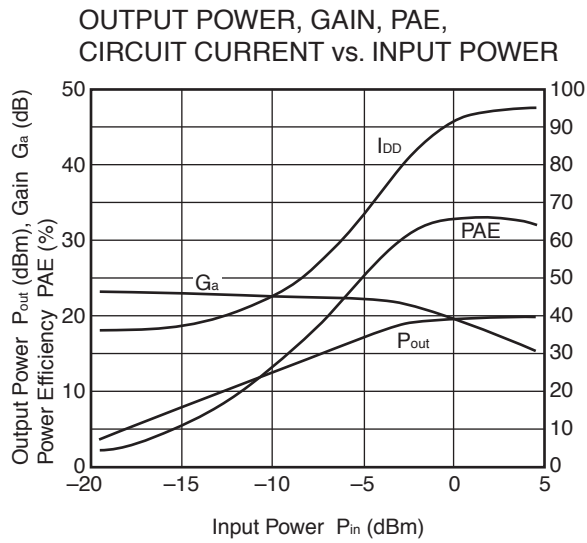

**Remark** The graphs indicate nominal characteristics.

**Tx mode S-PARAMETERS**

Condition :  $T_A = +25^\circ\text{C}$ ,  $V_{DD1, 2, 3} = 3.0\text{ V}$ ,  $V_{en} = 3.0\text{ V}$ ,  $V_{sw1}/V_{sw2} = 3.0\text{ V}/0\text{ V}$ ,  $P_{in} = -30\text{ dBm}$

S<sub>11</sub>-FREQUENCY

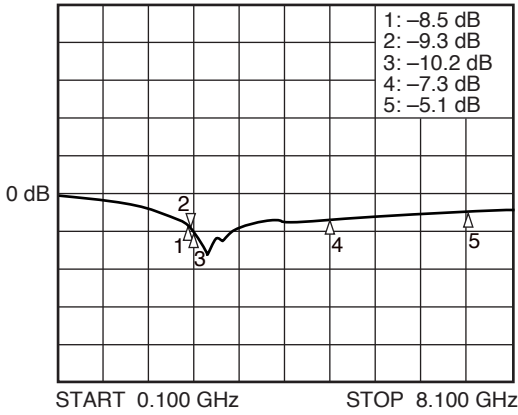

S<sub>12</sub>-FREQUENCY

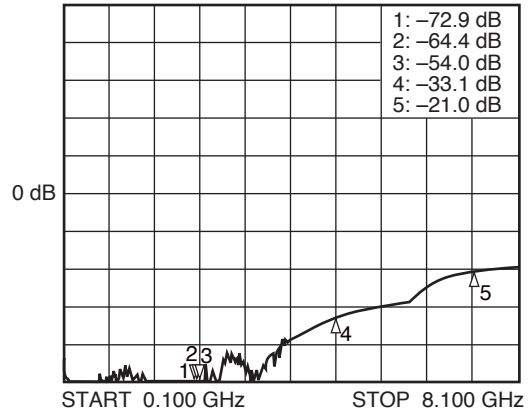

S<sub>21</sub>-FREQUENCY

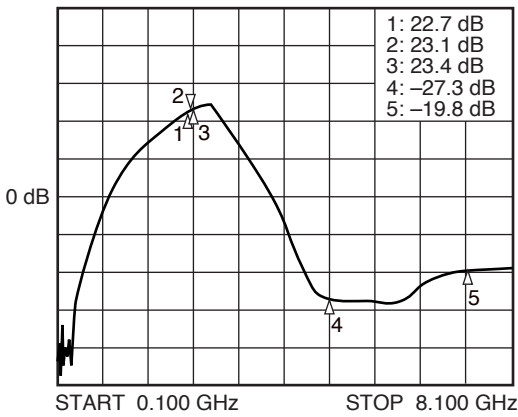

S<sub>22</sub>-FREQUENCY

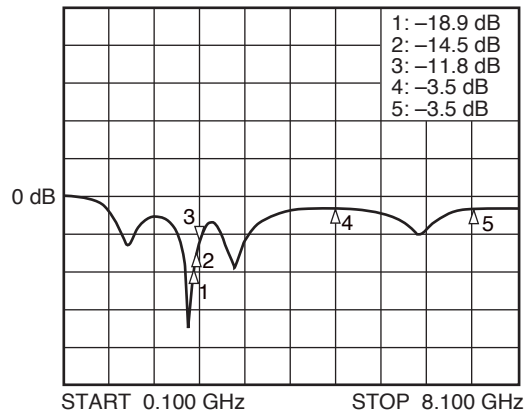

**Remarks 1.** The graphs indicate nominal characteristics.

- 2. Marker1 : 2.40 GHz
- Marker2 : 2.45 GHz
- Marker3 : 2.50 GHz
- Marker4 : 4.90 GHz
- Marker5 : 7.35 GHz

**Path mode S-PARAMETER**

Condition :  $T_A = +25^\circ\text{C}$ ,  $V_{DD1, 2, 3} = 3.0\text{ V}$ ,  $V_{en} = 3.0\text{ V}$ ,  $V_{sw1}/V_{sw2} = 0\text{ V}/3.0\text{ V}$ ,  $P_{in} = -30\text{ dBm}$

S<sub>21</sub>-FREQUENCY

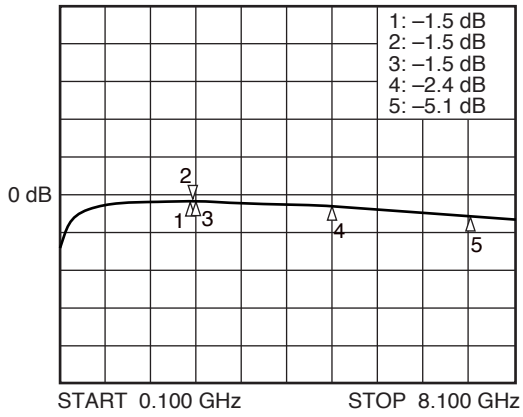

**Remarks 1.** The graph indicates nominal characteristics.

- 2. Marker1 : 2.40 GHz
- Marker2 : 2.45 GHz
- Marker3 : 2.50 GHz
- Marker4 : 4.90 GHz
- Marker5 : 7.35 GHz

**MOUNTING PAD LAYOUT DIMENSIONS**

**16-PIN PLASTIC QFN (UNIT: mm)**

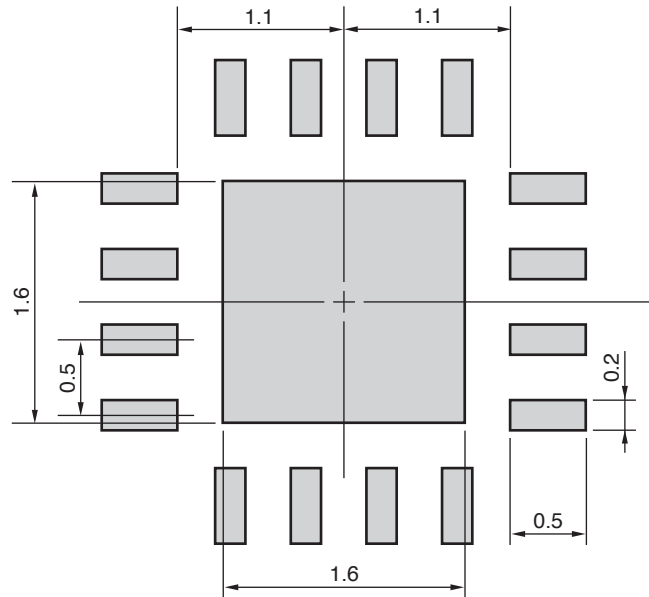

**Remark** The mounting pad layouts in this document are for reference only.  
 When designing PCB, please consider workability of mounting, solder joint reliability, prevention of solder bridge and so on, in order to optimize the design.

PACKAGE DIMENSIONS

16-PIN PLASTIC QFN (T6S) (UNIT: mm)

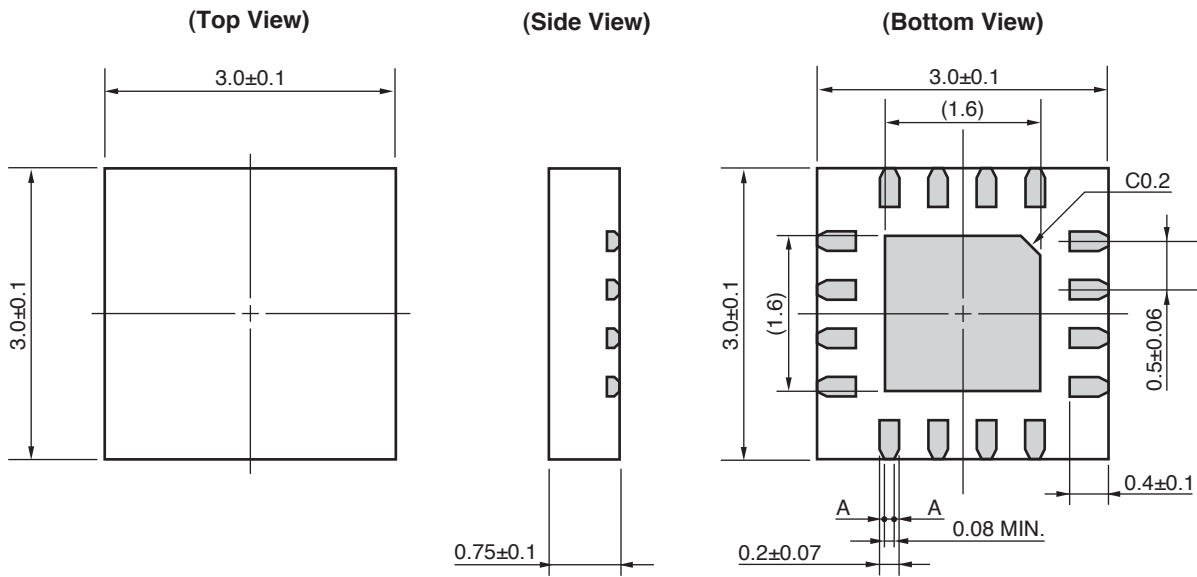

**Remark** A>0  
 ( ) : Reference value

**RECOMMENDED SOLDERING CONDITIONS**

This product should be soldered and mounted under the following recommended conditions. For soldering methods and conditions other than those recommended below, contact your nearby sales office.

Soldering Method	Soldering Conditions	Condition Symbol
Infrared Reflow	Peak temperature (package surface temperature) : 260°C or below Time at peak temperature : 10 seconds or less Time at temperature of 220°C or higher : 60 seconds or less Preheating time at 120 to 180°C : 120±30 seconds Maximum number of reflow processes : 3 times Maximum chlorine content of rosin flux (% mass) : 0.2%(Wt.) or below	IR260
Partial Heating	Peak temperature (terminal temperature) : 350°C or below Soldering time (per side of device) : 3 seconds or less Maximum chlorine content of rosin flux (% mass) : 0.2%(Wt.) or below	HS350

**Caution Do not use different soldering methods together (except for partial heating).**

Bluetooth is a trademark owned by Bluetooth SIG, Inc., U.S.A.

ZigBee is a trademark of Koninklijke Philips Electronics N.V.

• **The information in this document is current as of April, 2009. The information is subject to change without notice. For actual design-in, refer to the latest publications of NEC Electronics data sheets or data books, etc., for the most up-to-date specifications of NEC Electronics products. Not all products and/or types are available in every country. Please check with an NEC Electronics sales representative for availability and additional information.**

• No part of this document may be copied or reproduced in any form or by any means without the prior written consent of NEC Electronics. NEC Electronics assumes no responsibility for any errors that may appear in this document.

• NEC Electronics does not assume any liability for infringement of patents, copyrights or other intellectual property rights of third parties by or arising from the use of NEC Electronics products listed in this document or any other liability arising from the use of such products. No license, express, implied or otherwise, is granted under any patents, copyrights or other intellectual property rights of NEC Electronics or others.

• Descriptions of circuits, software and other related information in this document are provided for illustrative purposes in semiconductor product operation and application examples. The incorporation of these circuits, software and information in the design of a customer's equipment shall be done under the full responsibility of the customer. NEC Electronics assumes no responsibility for any losses incurred by customers or third parties arising from the use of these circuits, software and information.

• While NEC Electronics endeavors to enhance the quality, reliability and safety of NEC Electronics products, customers agree and acknowledge that the possibility of defects thereof cannot be eliminated entirely. To minimize risks of damage to property or injury (including death) to persons arising from defects in NEC Electronics products, customers must incorporate sufficient safety measures in their design, such as redundancy, fire-containment and anti-failure features.

• NEC Electronics products are classified into the following three quality grades: "Standard", "Special" and "Specific".

The "Specific" quality grade applies only to NEC Electronics products developed based on a customer-designated "quality assurance program" for a specific application. The recommended applications of an NEC Electronics product depend on its quality grade, as indicated below. Customers must check the quality grade of each NEC Electronics product before using it in a particular application.

"Standard": Computers, office equipment, communications equipment, test and measurement equipment, audio and visual equipment, home electronic appliances, machine tools, personal electronic equipment and industrial robots.

"Special": Transportation equipment (automobiles, trains, ships, etc.), traffic control systems, anti-disaster systems, anti-crime systems, safety equipment and medical equipment (not specifically designed for life support).

"Specific": Aircraft, aerospace equipment, submersible repeaters, nuclear reactor control systems, life support systems and medical equipment for life support, etc.

The quality grade of NEC Electronics products is "Standard" unless otherwise expressly specified in NEC Electronics data sheets or data books, etc. If customers wish to use NEC Electronics products in applications not intended by NEC Electronics, they must contact an NEC Electronics sales representative in advance to determine NEC Electronics' willingness to support a given application.

(Note)

(1) "NEC Electronics" as used in this statement means NEC Electronics Corporation and also includes its majority-owned subsidiaries.

(2) "NEC Electronics products" means any product developed or manufactured by or for NEC Electronics (as defined above).

<b>Caution</b>	GaAs Products	<p>This product uses gallium arsenide (GaAs). GaAs vapor and powder are hazardous to human health if inhaled or ingested, so please observe the following points.</p> <ul style="list-style-type: none"><li>• Follow related laws and ordinances when disposing of the product. If there are no applicable laws and/or ordinances, dispose of the product as recommended below.<ol style="list-style-type: none"><li>1. Commission a disposal company able to (with a license to) collect, transport and dispose of materials that contain arsenic and other such industrial waste materials.</li><li>2. Exclude the product from general industrial waste and household garbage, and ensure that the product is controlled (as industrial waste subject to special control) up until final disposal.</li></ol></li><li>• Do not burn, destroy, cut, crush, or chemically dissolve the product.</li><li>• Do not lick the product or in any way allow it to enter the mouth.</li></ul>
----------------	---------------	--