

THC63LVD827(-Q) Evaluation Kit

LVDS Dual Link Evaluation Board

Parts Number: THEVA827

1. General Description

THEVA827 is designed to evaluate THC63LVD827(-Q) for transmission video data. THC63LVD827(-Q) chipset can transmit 24bit RGB data and HS/VS/DE sync via dual channel LVDS. The maximum clock frequency of THC63LVD827(-Q) is 174MHz.

2. Features

THC63LVD827

- Low power 1.8V CMOS design (1.8~3.3V IO voltage supported)
- Power down mode
- Wide dot clock range suited for TV signal(480i to 1080p), PC signal(VGA to WUXGA)
- PLL requires no external components
- Clock edge selectable
- Single TTL in, Single/Dual LVDS (Open-LDI) out
- Double Edge Input(Single in/Dual out Mode)
- Additional 6bit only low power mode
- 2 LVDS Data Mapping Modes
- Pseudo Random Pattern Generation Circuit
- Support Reduced Swing LVDS for Lower EMI
- TFBGA 72 Pin 7x7mm 0.65mm pitch

3. Overview

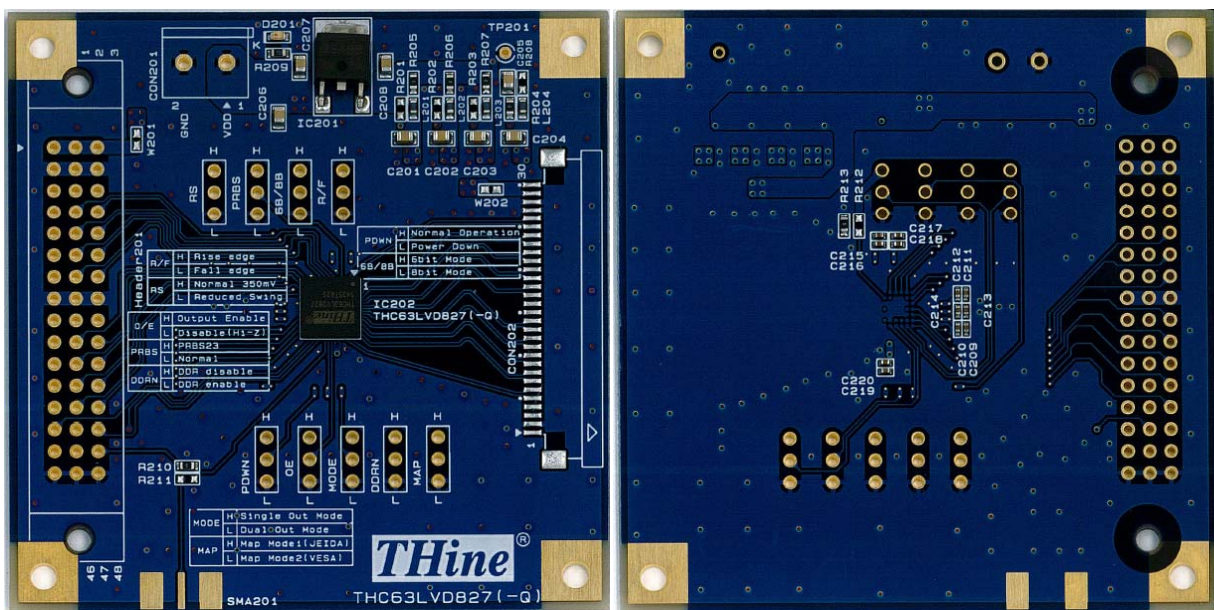

Figure 1 THEVA827

4. Power Supply Setup

This chapter shows power supply condition.

Caution: Please check if there is no power-GND short on below red trace before supplying any power.

1.8~3.3V Power Supply to the Board

Evaluation board requires 1.8~3.3V power supply. Please use “CON201” connector typically.

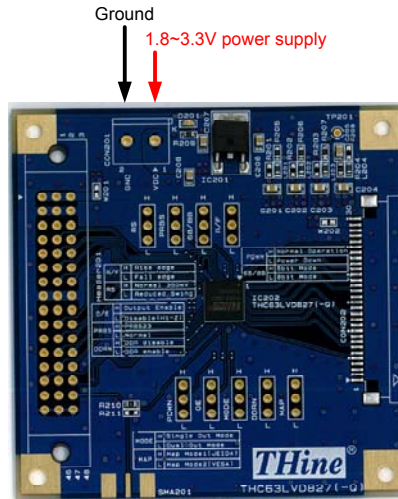

Figure 2 THEVA827 power supply for evaluation board

Power Supply from / to Connector

power supply can be connected to Header201 and CON202 by using W201 and W202 solder jumper.

THEVA827

W201: Connect the power supply with pin#1, 2 and 3 of Header201.

W202: Connect the power supply with pin#29 and 30 of CON202.

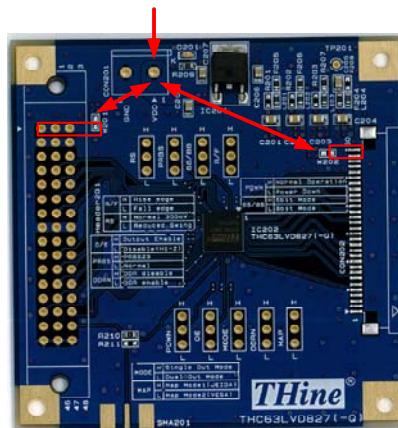

Figure 3 THEVA827 power supply from / to each Connector

5. Function Setting

Setting pin of the board is shown in yellow area of Figure 4.

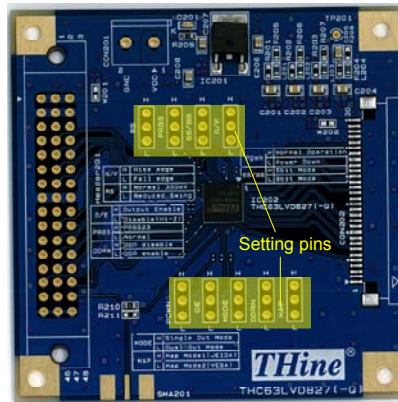
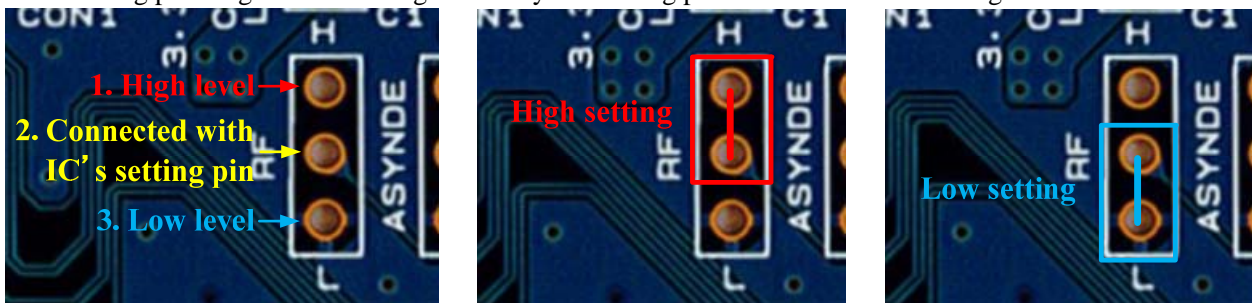

Figure 4 THEVA827 position of function setting pins

Pin#2 of each 3HEADER is connected to IC's setting pin.

Each setting pin's high or low setting can set by connecting pin#2 of 3HEADER and high level or low level.



(a)3HEADER Description

(b)High Level Setting

(c)Low Level Setting

Figure 5 Schematic diagram of High / Low setting description

6. Clock Input from SMA Connector

THEVA827 can also choose the TTL clock input from SMA connector by using 0ohm resistor. If you want to use SMA connector for clock input, please change the 0ohm resistor mount from R210 to R211.

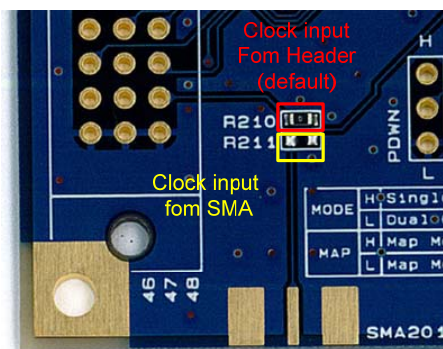

Figure 6 THEVA827 TTL clock input connector select

7. Status Indicate LED

LED “D201” indicates power supply status.

8. Function

This chapter shows function setting of THEVA827.

Table 1 THEVA827 Function Setting Description

Silk	Symbol	Function												
R/F	R/F	Input clock triggering edge select. H : Rising Edge L : Falling Edge												
RS	RS	LVDS swing mode, VREF select.												
		<table border="1"> <thead> <tr> <th>RS</th> <th>LVDS Swing</th> <th>Small Swing Input Support</th> </tr> </thead> <tbody> <tr> <td>V_{IHM}</td> <td>350mV</td> <td>N / A</td> </tr> <tr> <td>V_{IMM}</td> <td>350mV</td> <td>RS = V_{REF}</td> </tr> <tr> <td>V_{ILM}</td> <td>200mV</td> <td>N / A</td> </tr> </tbody> </table>	RS	LVDS Swing	Small Swing Input Support	V _{IHM}	350mV	N / A	V _{IMM}	350mV	RS = V _{REF}	V _{ILM}	200mV	N / A
		RS	LVDS Swing	Small Swing Input Support										
		V _{IHM}	350mV	N / A										
V _{IMM}	350mV	RS = V _{REF}												
V _{ILM}	200mV	N / A												
MAP	MAP	LVDS mapping table select <table border="1"> <thead> <tr> <th>MAP</th> <th>Mapping Mode</th> </tr> </thead> <tbody> <tr> <td>H</td> <td>Mapping MODE1</td> </tr> <tr> <td>L</td> <td>Mapping MODE2</td> </tr> </tbody> </table>	MAP	Mapping Mode	H	Mapping MODE1	L	Mapping MODE2						
MAP	Mapping Mode													
H	Mapping MODE1													
L	Mapping MODE2													
MODE	MODE	Pixel data mode select <table border="1"> <thead> <tr> <th>MODE</th> <th>Function</th> </tr> </thead> <tbody> <tr> <td>H</td> <td>Single Link (Single-in / Single-out)</td> </tr> <tr> <td>L</td> <td>Dual Link (Single-in / Dual -out)</td> </tr> </tbody> </table>	MODE	Function	H	Single Link (Single-in / Single-out)	L	Dual Link (Single-in / Dual -out)						
MODE	Function													
H	Single Link (Single-in / Single-out)													
L	Dual Link (Single-in / Dual -out)													
O/E	OE	Output enable H : Output Enable L : Output Disable (all outputs are Hi-Z)												
/PDWN	PDWN	Power down function setting H : Normal Operation L : Power Down Mode (All outputs are Hi-Z)												
PRBS	PRBS	PRBS (Pseudo Random Binary Sequence) generator is active for evaluation purposer H : PRBS Generator Enable L : Normal Operation												
6B/8B	6B/8B	6bit / 8bit mode select H : 6bit mode (21bit mode) L : 8bit mode (27bit mode)												
DDRN	DDRN	DDR enable when MODE=L (Dual out mode), Negative active polarity H : DDR (Double Edge input) function disable L : DDR (Double Edge input) function enable												

9. Schematic

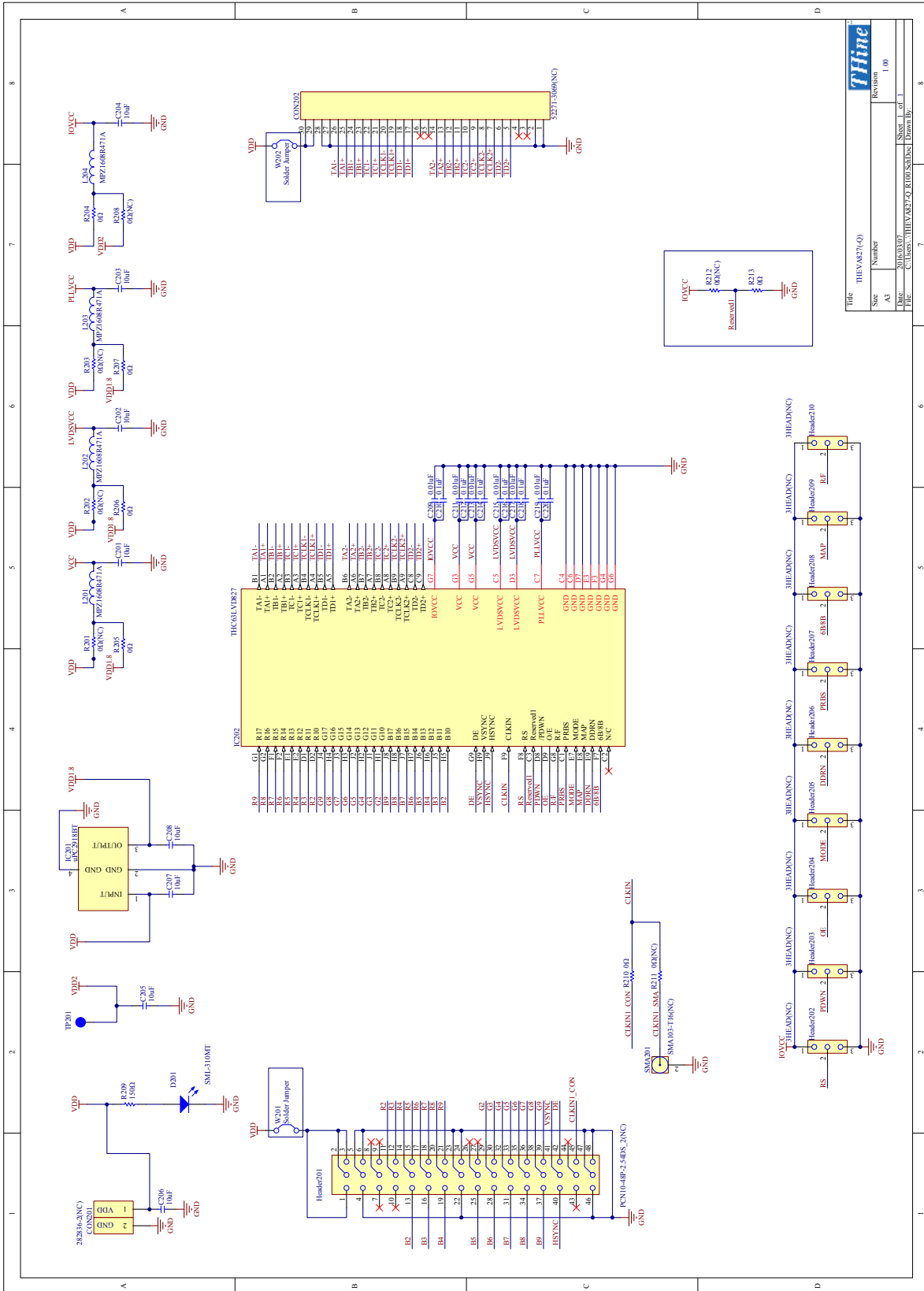

Figure 7 THEVA827 Schematic

10. Bill of Materials

Table 2 THEVA827 BOM

Comment	Description	Value	Note	Designator	Qty
Capacitor2012	2012	10uF	16V	C201, C202, C203, C204, C205, C206, C207, C208	8
Capacitor1005	1005	0.01uF	16V	C209, C211, C213, C215, C217, C219	6
Capacitor1005	1005	0.1uF	16V	C210, C212, C214, C216, C218, C220	6
282836-2	282836-2	282836-2(NC)	5mm pitch	CON201	1
CN-FFC(1.0)30PD	CN-FFC(1.0)30PD	52271-3069(NC)	1mm pitch	CON202	1
LED1608	1608	SML-310MT	Green	D201	1
3HEAD	3HEAD	3HEAD(NC)	2.54mm pitch	Header202, Header203, Header204, Header205, Header206, Header207, Header208, Header209, Header210	9
uPC2918BT	SC-63			IC201	1
THC63LVD827	TFBGA72			IC202	1
Inductor1608	1608	MPZ1608R471A		L201, L202, L203, L204	4
Resistor1608	1608	0ohm	1A(0ohm)	R205, R206, R207, R204, R210, R213	6
Resistor1608	1608	150Ω	0.1W	R209	1

11. Set Items

Table 3 Set Items

TYPE	Part No.
DC Connector	282836-2
FFC Connector for LVDS Link	52271-3069
FFC 30pin 1mm Pitch for LVDS Link	98267-0475
Pin Header	---

It's possible to mount these parts on this board and use.

12. Notices and Requests

Please kindly read, understand and accept this “Notices and Requests” before using this product.

For the Material:

1. The product specifications described in this material are subject to change without prior notice.
2. The circuit diagrams described in this material are examples of the application which may not always apply to design of respective customers. THine Electronics, Inc. (“THine”) is not responsible for possible errors and omissions in this material. Please note if the errors or omissions should be found in this material, THine may not be able to correct them immediately.
3. This material contains THine’s copyright, know-how or other proprietary. Copying or disclosing of the contents of this material to any third party without THine’s prior permission is strictly prohibited.

For the Product:

1. This product is solely designed for evaluation purpose, and other purposes including mass production and distribution are not intended.
2. This product has been solely manufactured for electric design engineers but not for end-users.
3. This product is not radiation-tolerant product.
4. This product is presumed to be used for general electric device, not for applications which require extremely high-reliability/safety (including medical device concerned with critical care, aerospace device, or nuclear power control device). Also, when using this product for any device concerned with control and/or safety of transportation mean, traffic signal device, or other various types of safety device, such use must be after applying appropriate measures to the product.
5. This product has been designed with the utmost care to accomplish the purpose of evaluation of IC products manufactured by THine Electronics, Inc., however, THine **MAKES NO WARRANTIES OR REPRESENTATIONS WITH REGARD TO ANY PERFORMANCE OR FUNCTION OF THIS PRODUCT IN ANY CIRCUMSTANCE.**
6. This product has been manufactured with the utmost care in quality control and product reliability, however, there may be faults or defects with a low but fixed probability, as inevitable phenomenon concerned with semiconductor manufacturing processes. Therefore, Customers are encouraged to have sufficiently redundant or error-preventive design applied to the use of the product so as not to have THine’s product cause any social or public damage. Replacement of the product is only available in case of obvious defects of mount devices at the point of unpacking the product. Neither replacement nor failure analysis of the product is available in any other case of defects with the product and/or the product’s components.
7. Customers are asked, if required, to judge by themselves on whether this product falls under the category of strategic goods under the Foreign Exchange and Foreign Trade Control Law.
8. Please Note that if infringement of any third party’s industrial ownership should occur by using this product, THine will be exempted from any responsibility unless it directly relates to the production process or functions of the product.
9. Developing, designing and manufacturing of Customers’ own products, equipments or system by using of this product is strictly prohibited in any way.

THine Electronics, Inc.

sales@thine.co.jp